



Network Camera

Installation Manual

DC-Y1513

DC-Y1513W

DC-Y1514

DC-Y1514W

Before reading this manual



This is a basic installation manual for use of an IDIS network camera. Users who are using this product for the first time, as well as users with experience using comparable products, must read this operation manual carefully before use and heed to the warnings and precautions contained herein while using the product. Safety warnings and precautions contained in this operation manual are intended to promote proper use of the product and thereby prevent accidents and property damage and must be followed at all times. Once you have read this operation manual, keep it at an easily accessible location for future reference.

-  • The manufacturer will not be held responsible for any product damage resulting from the use of unauthorized parts and accessories or from the user's failure to comply with the instructions contained in this manual.
- The information in this document is believed to be accurate as of the date of publication even though explanation about some functions may not be incorporated. The manufacturer is not responsible for any problems resulting from the use thereof. The information contained herein is subject to change without notice. Revisions or new editions to this publication may be issued to incorporate such changes.
- It is recommended that first-time users of this network camera and individuals who are not familiar with its use seek technical assistance from their retailer regarding product installation and use.
- If you need to disassemble the product for functionality expansion or repair purposes, you must contact your retailer and seek professional assistance.
- Both retailers and users should be aware that this product has been certified as being electromagnetically compatible for commercial use. If you have sold or purchased this product unintentionally, please replace with a consumer version.

Safety Symbols

Symbol	Publication	Description
	IEC60417, No.5031	Direct current

In-Text

Symbol	Type	Description
	Caution	Important information concerning a specific function.
	Note	Useful information concerning a specific function.

Safety Precautions

WARNING

RISK OF ELECTRIC SHOCK
DO NOT OPEN

WARNING: TO REDUCE THE RISK OF ELECTRIC SHOCK,
DO NOT REMOVE COVER (OR BACK).
NO USER-SERVICEABLE PARTS INSIDE.
REFER SERVICING TO QUALIFIED SERVICE PERSONNEL.

Important Safeguards

1. Read Instructions

All the safety and operating instructions should be read before the appliance is operated.

2. Retain Instructions

The safety and operating instructions should be retained for future reference.

3. Cleaning

Unplug this equipment from the wall outlet before cleaning it. Do not use liquid aerosol cleaners. Use a damp soft cloth for cleaning.

4. Attachments

Never add any attachments and/or equipment without the approval of the manufacturer as such additions may result in the risk of fire, electric shock or other personal injury.

5. Water and/or Moisture

Do not use this equipment near water or in contact with water.

6. Placing and Accessories

Do not place this equipment on a wall or ceiling that is not strong enough to sustain the camera. The equipment may fall, causing serious injury to a child or adult, and serious damage to the equipment. Wall or shelf mounting should follow the manufacturer's instructions, and should use a mounting kit approved by the manufacturer.



This equipment and cart combination should be moved with care. Quick stops, excessive force, and uneven surfaces may cause the equipment and cart combination to overturn.

Do not place this equipment in an enclosed space. Sufficient ventilation is required to prevent an increase in ambient temperature which can cause malfunction or the risk of fire.

7. Power Sources

This equipment should be operated only from the type of power source indicated on the marking label. If you are not sure of the type of power, please consult your equipment dealer or local power company. You may want to install a UPS (Uninterruptible Power Supply) system for safe operation in order to prevent damage caused by an unexpected power stoppage. Any questions concerning UPS, consult your UPS retailer.

This equipment should be remain readily operable.

8. Power Cord

Operator or installer must remove power and TNT connections before handling the equipment.

9. Lightning

For added protection for this equipment during a lightning storm, or when it is left unattended and unused for long periods of time, unplug it from the wall outlet and disconnect the antenna or cable system. This will prevent damage to the equipment due to lightning and power-line surges. If thunder or lightning is common where the equipment is installed, use a surge protection device.

10. Overloading

Do not overload wall outlets and extension cords as this can result in the risk of fire or electric shock.

11. Objects and Liquids

Never push objects of any kind through openings of this equipment as they may touch dangerous voltage points or short out parts that could result in a fire or electric shock. Never spill liquid of any kind on the equipment.

12. Servicing

Do not attempt to service this equipment yourself. Refer all servicing to qualified service personnel.

13. Damage requiring Service

Unplug this equipment from the wall outlet and refer servicing to qualified service personnel under the following conditions:

- A. When the power-supply cord or the plug has been damaged.
- B. If liquid is spilled, or objects have hit the equipment.
- C. If the equipment has been exposed to rain or water.
- D. If the equipment does not operate normally by following the operating instructions, adjust only those controls that are covered by the operating instructions as an improper adjustment of other controls may result in damage and will often require extensive work by a qualified technician to restore the equipment to its normal operation.
- E. If the equipment has been dropped, or the cabinet damaged.
- F. When the equipment exhibits a distinct change in performance — this indicates a need for service.

14. Replacement Parts

When replacement parts are required, be sure the service technician has used replacement parts specified by the manufacturer or that have the same characteristics as the original part. Unauthorized substitutions may result in fire, electric shock or other hazards.

15. Safety Check

Upon completion of any service or repairs to this equipment, ask the service technician to perform safety checks to determine that the equipment is in proper operating condition.

16. Field Installation

This installation should be made by a qualified service person and should conform to all local codes.

17. Correct Batteries

Warning: Risk of explosion if battery is replaced by an incorrect type. Replace only with the same or equivalent type.

Dispose of used batteries according to the instructions.

The battery shall not be exposed to excessive heat such as sunshine, fire or the like.

18. Tmra

A manufacturer's maximum recommended ambient temperature (Tmra) for the equipment must be specified so that the customer and installer may determine a suitable maximum operating environment for the equipment.

FCC Compliance Statement

THIS EQUIPMENT HAS BEEN TESTED AND FOUND TO COMPLY WITH THE LIMITS FOR A CLASS A DIGITAL DEVICE, PURSUANT TO PART 15 OF THE FCC RULES. THESE LIMITS ARE DESIGNED TO PROVIDE REASONABLE PROTECTION AGAINST HARMFUL INTERFERENCE WHEN THE EQUIPMENT IS OPERATED IN A COMMERCIAL ENVIRONMENT. THIS EQUIPMENT GENERATES, USES, AND CAN RADIATE RADIO FREQUENCY ENERGY AND IF NOT INSTALLED AND USED IN ACCORDANCE WITH THE INSTRUCTION MANUAL, MAY CAUSE HARMFUL INTERFERENCE TO RADIO COMMUNICATIONS. OPERATION OF THIS EQUIPMENT IN A RESIDENTIAL AREA IS LIKELY TO

CAUSE HARMFUL INTERFERENCE, IN WHICH CASE USERS WILL BE REQUIRED TO CORRECT THE INTERFERENCE AT THEIR OWN EXPENSE.

WARNING: CHANGES OR MODIFICATIONS NOT EXPRESSLY APPROVED BY THE PARTY RESPONSIBLE FOR COMPLIANCE COULD VOID THE USER'S AUTHORITY TO OPERATE THE EQUIPMENT. THIS CLASS OF DIGITAL APPARATUS MEETS ALL REQUIREMENTS OF THE CANADIAN INTERFERENCE CAUSING EQUIPMENT REGULATIONS.

WEEE (Waste Electrical & Electronic Equipment)

Correct Disposal of This Product

(Applicable in the European Union and other European countries with separate collection systems)



This marking shown on the product or its literature, indicates that it should not be disposed with other household wastes at the end of its working life. To prevent possible harm to the environment or human health from uncontrolled waste disposal, please separate this from other types of wastes and recycle it responsibly to promote the sustainable reuse of material resources.

Household users should contact either the retailer where they purchased this product, or their local government office, for details of where and how they can take this item for environmentally safe recycling.

Business users should contact their supplier and check the terms and conditions of the purchase contract. This product should not be mixed with other commercial wastes for disposal.

Copyright

© 2017 IDIS Co., Ltd.

IDIS Co., Ltd. reserves all rights concerning this operation manual.

Use or duplication of this operation manual in part or whole without the prior consent of IDIS Co., Ltd. is strictly prohibited.

Contents of this operation manual are subject to change without prior notice for reasons such as functionality enhancements.

Registered Trademarks

IDIS is a registered trademark of IDIS Co., Ltd.

Other company and product names are registered trademarks of their respective owners.

This product contains software built partially on open-source content. Codes for the corresponding open-source content are available for download. For more information, refer to the software CD (OpenSourceGuide\OpenSourceGuide.pdf) or the open source guide accompanying this operation manual.

Table of Contents

1

Part 1 – Introduction	6
Product Features	6
Accessories	7
Overview	8
Top Cover	8
Body	8
I/O Device Port	9
Factory Reset	11
Installation	11
Inserting a SD Memory Card	11
Installation	12
Dimensions	14

2

Part 2 - Camera Connection	16
With DirectIP™ NVR-based Layout	16
With non DirectIP™ NVR-based Layout	17

3

Part 3 - Appendix	18
Troubleshooting	18
Specifications	19

Part 1 – Introduction

Product Features

DC-Y1513 / DC-Y1513W / DC-Y1514 / DC-Y1514W are IP-based network cameras that compress and transmit video over ethernet.

You can use the IDIS Discovery program to change network camera settings or the IDIS Solution Suite Compact program to manage multiple network cameras. In addition, the embedded web server (IDIS Web) lets you remotely view live video or scan recorded video using a web browser. In addition, you can use the IDIS Solution Suite Compact to manage network cameras and view/record video.



In this operation manual, the term **Remote System** refers to the computer on which the remote program (IDIS Solution Suite Compact or IDIS Web) is running.

- Supports DirectIP mode working with a DirectIP™ NVR that allows users to simply set up all required configurations without a PC
- Multi-streaming for high-resolution and high-quality video monitoring and simultaneous recording in real-time as well as flexible configurations for those
- Supports H.264 video compression and M-JPEG still image compression algorithms
- Supports 4-stage video compression rate and multiple compression resolutions
- Bidirectional audio communication support for remote audio dialog
- Video stream buffering to counter pre-/post-event buffering and network delays for improved network recording reliability
- Remote monitoring via web browser or remote software
- Automatic web casting code (HTML) generation
- Up to 10 simultaneous remote connections

- IP filtering, HTTPS, SSL, IEEE 802.1X, and configurable user authority levels for greater security
- Network bandwidth limitation and MAT features for more efficient use of network bandwidth
- Easy network access via UPnP (Universal Plug and Play) function and embedded mDNS (Multicast DNS) protocol
- Supports ONVIF protocol (Core specification version 2.4.0)
- Wide dynamic range compensation (WDR) for improved video quality in high-contrast situations
- Slow shutter support for improved low-lighting video capture performance
- Day & Night feature (built-in IR cut filter changer)
- Quick and easy firmware upgrade over the network
- Redundant firmware and auto recovery features for improved system stability
- Network-based integrated management of multiple network cameras
- Multiple event detection modes: Alarm-in, motion detection, trip zone, audio detection, and tampering
- Backup storage on a microSD memory card as a safeguard against data loss during network interruptions
- Supports 12 VDC and PoE (Power over Ethernet)
- Features a built-in microphone (*DC-Y1514 / DC-Y1514W model only*)



Remote monitoring and recording via multistreaming are available using the IDIS Solution Suite Compact program. For more information on using IDIS Solution Suite Compact, refer to its **operation manual**.



There is a limit to the number of users allowed to connect remotely via the Internet at the same time.

Accessories

Upon purchasing the product, check inside the box to make sure all the following accessories are included. External appearances and colors of the accessories may vary depending on the model.

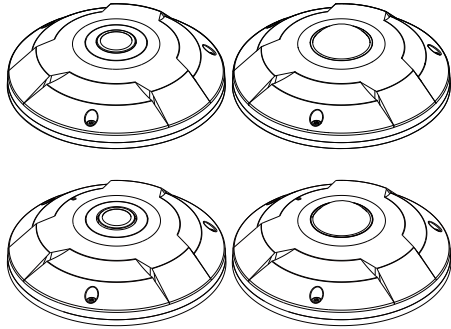

Network Camera

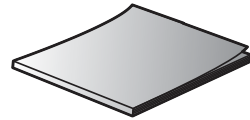

Open Source Guide

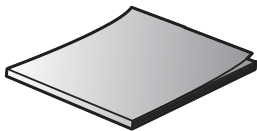

Quick Guide



Allen Wrench

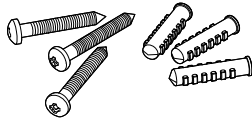

Screws (3 ea.)

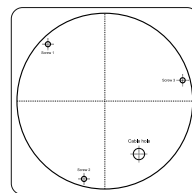

Guide Pattern

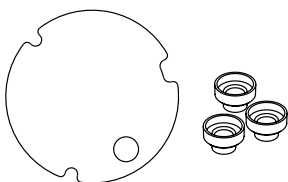

Insulator, Bushings

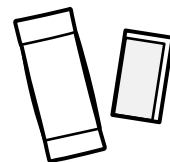

Desiccant (*DC-Y1513W / DC-Y1514W model only*)

Overview

Product color and design may vary depending on the model.

Top Cover

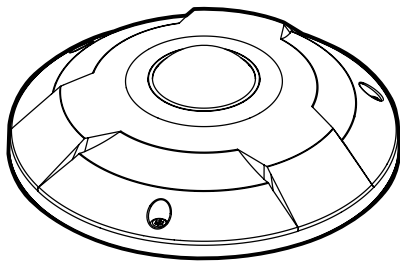

Body

DC-Y1513 / DC-Y1513W

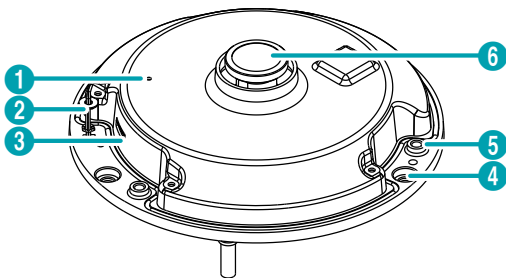

DC-Y1514 / DC-Y1514W

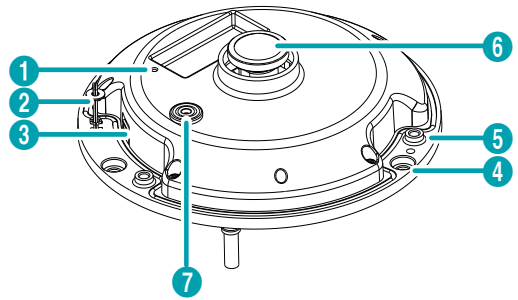

①	Factory Reset Button
②	Safety wire
③	SD Memory Card Slot
④	Wall/Ceiling Installation Hole
⑤	Top Cover Screw Hole
⑥	Lens
⑦	Built-in Microphone

• **Factory Reset Button**

Restores the camera's default factory settings. For more information, refer to the **Factory Reset** on page 11.

• **Safety Wire**

Prevents the top cover from falling on to the floor when detached from the camera.

• **SD Memory Card Slot**

Used to insert a microSD memory card into the camera. (An SLC (Single Level Cell) or MLC (Multi Level Cell) card by SanDisk or Transcend is recommended) For more information, refer to the **Inserting a SD Memory Card on page 11.**



- Do not remove the SD memory card while the system is in operation. Removing the card while the system is in operation can cause the system to malfunction and/or corrupt data stored on the SD memory card.
- An SD memory card is a consumable product with a finite service life. Prolonged use will damage the card's memory sectors and result in data loss or memory card failure. Test the SD memory card regularly and replace it whenever necessary.

• **Wall/Ceiling Installation Hole**

Used to screw the camera in place on a wall or a ceiling.

• **Top Cover Screw Hole**

Secures the top cover to the body.

• **Lens**

A lens is mounted.



- Before you install this product, remove the peel off film attached to the surface of the lens.

• **Built-in Microphone**

Receives audio.

I/O Device Port

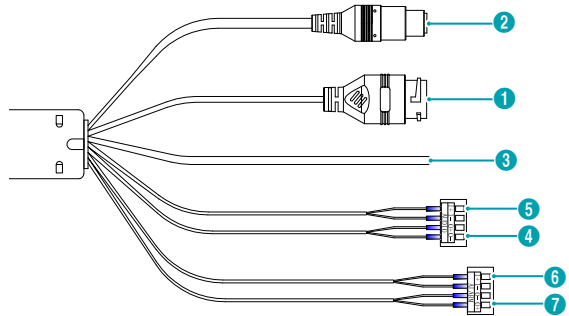
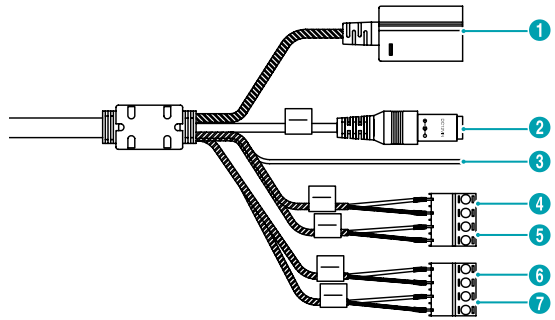

①	Network Port
②	Power Connector
③	FGND (Frame Ground)
④	Audio Out
⑤	Audio In
⑥	Alarm In
⑦	Alarm out

• **Network Port**

Connect a network cable with an RJ-45 connector to this port. If using a PoE switch, you can supply power to the camera using an ethernet cable. For more information on PoE switch use, refer to the switch manufacturer's operation manual. You can configure, manage, and upgrade this camera and monitor its images from a remote computer over the network. For more information on network connection setup, refer to the **IDIS Discovery operation manual.**

• **Power (DC12V)**

Connect this to the power adapter. An A-type jack is used for the power adapter. (External diameter x internal diameter: 5.5 mm x 2.5 mm(0.22" x 0.10"))

Part 1 – Introduction



The following table describes the 12 VDC wire and network cable specifications.

< 12 VDC wire specifications >

Diameter (AWG)	#22	#20	#18
Length (Maximum)	19m	30m	48m

The table below shows the network cable specifications.

<The network cable specifications>

Item	Content	Note
Connector	RJ-45	
Ethernet	10/100/1000 Base	10/100/1000 Mbps
Cable	UTP Category 5e or higher	
Maximum length	100m	
PoE	IEEE 802.3af, Class 3	

• **FGND (Frame Ground)**

Used to ground the device.

• **Audio Out**

Connect an amplifier to this port (line out). This device does not feature a built-in audio amplifier unit and therefore requires the user to purchase a separate speaker system with a built-in amplifier.

• **Audio In**

Connect an audio source to this port (line in). A built-in microphone is featured on the front (*DC-Y1514 / DC-Y1514W model* only).

• **Alarm In / Out**

- **In:** Connect an alarm-in device to this port.

(Mechanism: Choose between an NC (Normally Closed) type or an NO (Normally Open) type) →

Connect a mechanical or electrical switch to the alarm in port and the GND (ground) connector.

Alarm in range is 0V to 5V. In order to detect alarm input from an electrical switch, the signal must be higher than 4.3V from an NC switch or less than 0.3V from an NO switch and must last for longer than 0.5 seconds.

- **Out:** It is the BJT (Bipolar Junction Transistor) - open collector output. If the voltage and current exceed the specification limit (Max. load: 30mA, Max. Voltage: 5VDC), the product could be damaged. When connecting the device which exceeds the specification limit, refer to the picture (circuit) below.



If used with an external inductive load (e.g. relay), a diode must be connected in parallel with the load for protection. Otherwise, the product could be damaged.

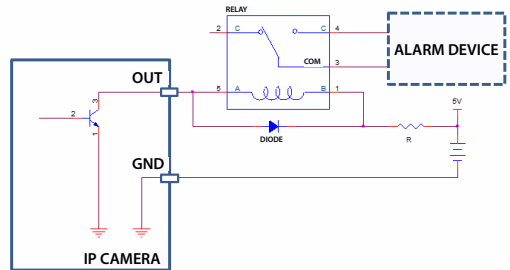

- Check your local laws and regulations on making video or audio recordings. The user will be held liable for any violation of the law. (Article 25-5 of the Personal Information Protection Act: Operators of image data processing devices may not operate such devices for purposes other than as originally intended during device installation, place such devices at locations other than as originally intended, or use such devices to record audio.)
- When switching over from 12 VDC to PoE as the power source, the system will be rebooted once the power adapter is disconnected.
- Ground the power port's frame ground terminal before use.
- Organize the power cable so that it will not cause people to trip over or become damaged from chairs, cabinets, desks, and other objects in the vicinity. Do not run the power cable underneath carpet or a rug or plug the cable into a power outlet shared by a number of other devices.

Factory Reset

Only use the factory Reset Button to restore the camera to its factory default settings.

 A factory reset will clear all camera settings configured by the user.

- 1 Remove the power connector from the power adapter to cut off the power supply
- 2 Remove the top cover, and then press and hold the reset button down.
- 3 Hold the switch down and reconnect the power adapter.
- 4 Once the device turns back on, wait 5 seconds, and then release the reset button.
- 5 The device will go through the resetting process and reboot. All camera settings will be restored to their factory defaults after the reboot.

 It's also possible to do a factory reset by pressing and releasing the reset button while the camera is turned on or using the IDIS Discovery program from a remote location. A factory reset will reboot the system. For more information on factory reset, refer to the **IDIS Discovery operation manual**.

Installation

Installation of this product does not require the use of special tools.

For more information on other devices comprising the overall system, refer to their respective **installation manuals**.

 Product color and design may vary depending on the model.

Inserting a SD Memory Card

- 1 Loosen the screws counterclockwise using the allen wrench provided with the product.
 -  Do not remove the screws from the top cover, otherwise, they may hurt you when they fall off.
 - Do not remove the safety wire from the top cover and camera body. It prevents the top cover from falling on to the floor when detached from the camera.

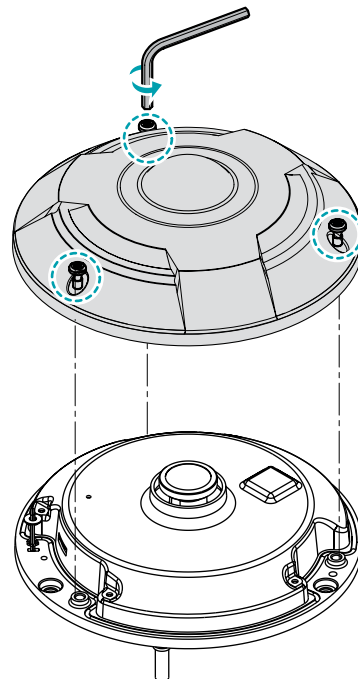

Part 1 – Introduction

- 2 Remove the top cover.
- 3 Insert a SD memory card into the SD memory card slot with the 'micro SD' print facing upward.

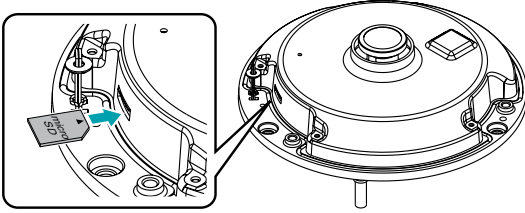

- ✓ Push the SD memory card until it disengages from the slot, and then pull it out.

Installation

- ⚠ Check the wall or ceiling to see if it needs to be reinforced. The camera may fall off if the wall or ceiling is not strong enough to support its weight.
 - Do not touch the surface of the lens. You must be extra careful when installing the *DC-Y1513 / DC-Y1514* model because its lens protrudes.
 - Install the camera in a shaded area. If the camera is installed in direct sunlight, it may be affected adversely.
- ✓ Use the provided guide pattern to check the distance between the screw holes if necessary.

- 1 Remove the white paper of the provided insulator and attach it to the wall or ceiling. This may reduce noise which could occur when the camera is installed on a metallic surface.

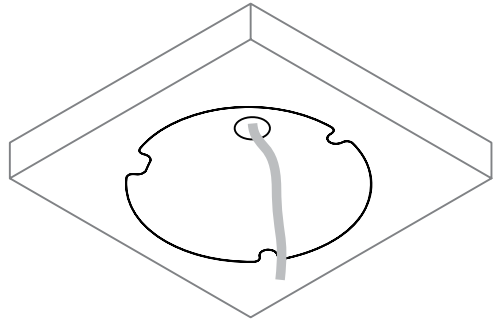

- 2 After you insert the SD memory card in the camera, secure the body on a wall or ceiling using the screws, bushings, and anchors that came with the camera.

- ⚠ Do NOT use the bushings if you did not attach the insulator to the wall or ceiling.
- ✓
 - Make it sure that a safety wire is connected to the top cover and camera body. It prevents the top cover from falling on to the floor when detached from the camera.
 - Attach the enclosed desiccant in the body to prevent moisture. (*DC-Y1513W / DC-Y1514W model only*)
 - After securing the body, remove the peel off film from the lens. (*DC-Y1513 / DC-Y1514 model only*)

DC-Y1513 / DC-Y1513W

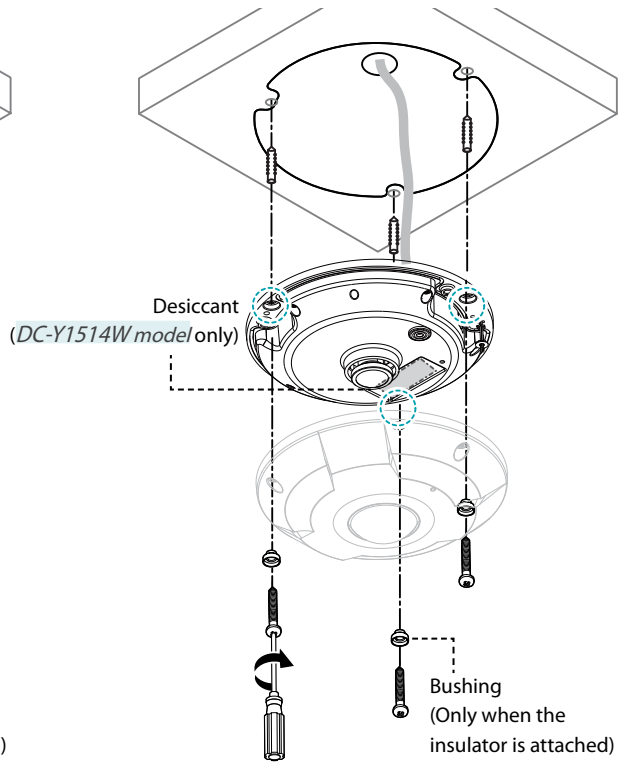
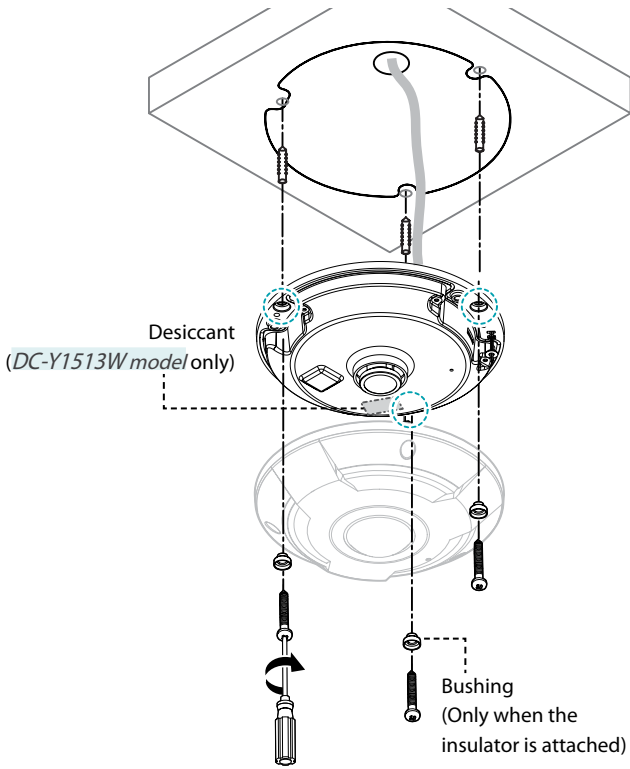

If you install the camera on a wall, check the direction of the camera body to prevent image from being turned upside down.



If you install the camera on a wall, check the direction of the camera body to prevent image from being turned upside down.

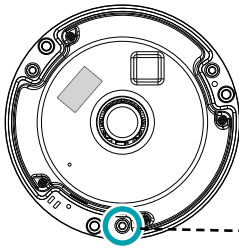

It should be placed downward.

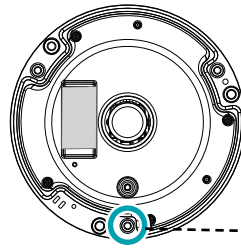

It should be placed downward.

DC-Y1514 / DC-Y1514W

Part 1 – Introduction

- 3 Connect external devices, the network cable, and the power adapter.
- 4 Secure the top cover to the body by turning the screws clockwise with the Allen wrench.

After securing the top cover, remove the peel off film from the dome port. (DC-Y1513W/DC-Y1514W model only)

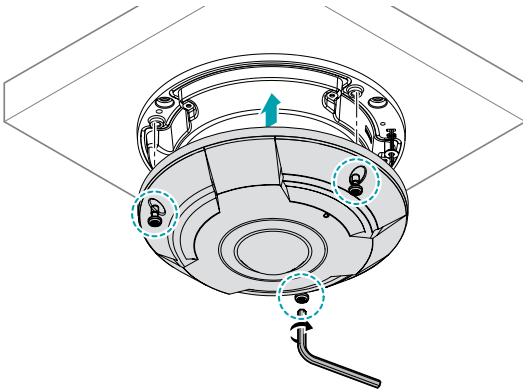

Dimensions

Camera - DC-Y1513W Model

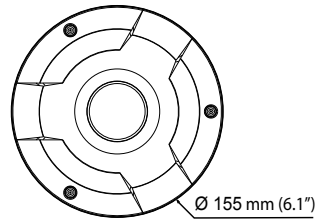
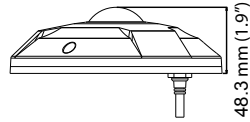

Camera - DC-Y1513 Model

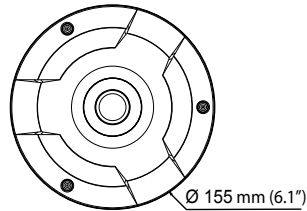
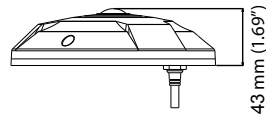

Camera - DC-Y1514 Model

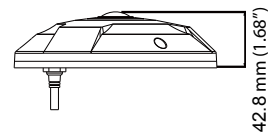
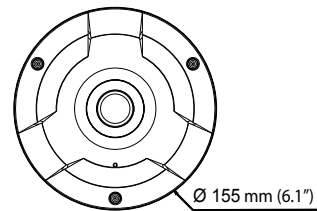

Camera - DC-Y1514W Model

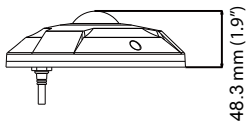
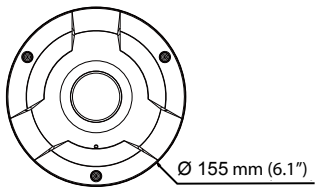

Insulator

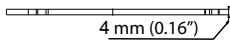

Part 2 - Camera Connection

Use the camera by connecting to DirectIP™ NVR or non DirectIP™ NVR, VMS such as IDIS Solution Suite Compact.

With DirectIP™ NVR-based Layout

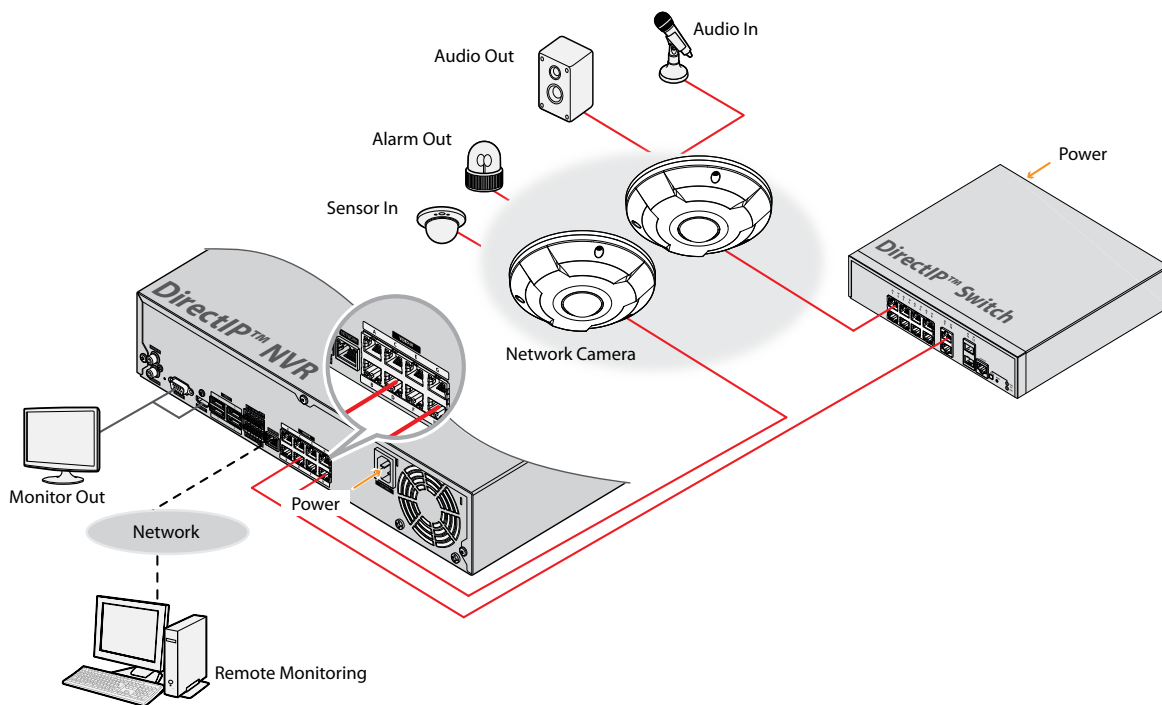

DirectIP™ NVR makes it easy to use cameras without extra network configurations. Each camera can be controlled via the DirectIP™ NVR setup menu, without any PC. For detailed camera settings, please see the camera setting pages of DirectIP™ NVR manual.

For users using the camera with DirectIP™ NVR connection, do not need to consider contents in the camera operation manual.

With non DirectIP™ NVR-based Layout

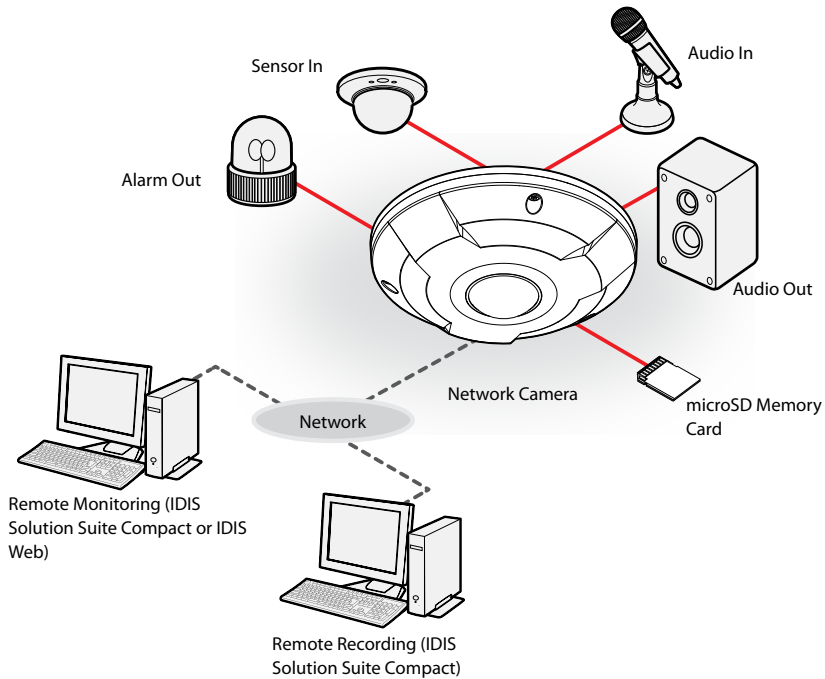

Control the camera over the network from software installed on a computer.
Ideal for using the camera over the network from a remote location.

The contents in the camera operation manual are only for users using the camera with non DirectIP™ NVR connection or VMS connection such as IDIS Solution Suite Compact.

Part 3 - Appendix

Troubleshooting

Problem	Check
The main unit won't turn on.	<ul style="list-style-type: none">• Check the power cable connection.• Check the power outlet.
PoE switch isn't being recognized.	Check the grounding status of the I/O device connected to the camera and the PoE switch. If they are not grounded, ground them and try again.
I can't see Live videos.	<ul style="list-style-type: none">• Check the camera's power status.• Ensure that cables are properly connected to the camera and the lens.• Check the network connection status of the computer and the network camera.
Images are blurry.	<ul style="list-style-type: none">• Make sure the lens is clean. If not, clean it using a soft piece of cloth or a brush.• Make sure the lens is in focus. Adjust the focus during daytime.• If there is too much light coming into the camera or the camera is picking up an overly bright light source, adjust the camera's position/angle accordingly.
Video color appears incorrect.	Check the white balance settings. If using the Auto option, it may take some time for the white balance to be adjusted.
Images are blinking.	If the camera is pointed at the sun or a fluorescent lamp, adjust the camera's angle away.
Lost the admin ID and password and unable to connect to a network camera.	You must perform a factory reset. A factory reset will revert all settings, including network settings, to their factory defaults. After performing a factory reset, make a memo of the admin ID and password as a safety precaution.
Unable to launch IDIS Web.	If the IDIS Web login screen is not loading, check which version of Microsoft Internet Explorer you are using. IDIS Web may not launch properly on versions 8.0 or below.

Specifications



These product specifications may change without prior notice.

Video

Image Sensor	1/1.8" CMOS
Max. Resolution	2560 x 2048
Scanning Mode	Progressive Scan
Lens type	Fixed-focal
Focal Length	f=1.45mm
Aperture	F2.2
Iris Control	Fixed Iris
Angular Field of View	H: 180° / V: 180° / D: 180°
Min. Illumination	Color : 0.8 lux @ F2.2 B/W : 0.003 lux @ F2.2
Dynamic Range	> 70dB (90dB@digital WDR)
Electronic Shutter Speed	Auto / Manual (1/30 ~ 1/8,000), Anti-Flicker, Slow Shutter(1/7.5, 1/15)
Day & Night	IR cut filter with auto switch
Viewing Composition	1O, 1P, 1P2R, 2P, 4R, 1O7R

Network

Video Compression	H.264(MPEG-4 Part 10/AVC), M-JPEG	
Bitrate Control	H.264 - VBR	
Max. Frame Rate	30fps: 2560 x 2048	
Audio Compression	G.726, G.711	
Supported Resolution	DirectIP™	2560x2048, 1536x1536, 512x 512
	Non DirectIP™	2560x2048, 1280x1024, 640x512, 2048x2048, 2048 x 1024, 1536x1536, 1024x1024, 1024 x 512, 512x512
Multi-Video Streaming	DirectIP™	Quadruple
	Non DirectIP™	Hextuple
Ethernet	RJ45(10/100/1000BASE-T)	
Edge Storage * (Optional)	 (micro SD/SDHC/SDXC (Class 6 or above, up to 128 GB))	

* An SLC (Single Level Cell) or MLC (Multi Level Cell) card by SanDisk or Transcend is recommended to ensure stable recording performance.

* An SD memory card is a consumable product with a finite service life. Prolonged use will damage the card's memory sectors and result in data loss or memory card failure. Test the SD memory card regularly and replace it whenever necessary.

* microSD Logo is a trademark of SD-3C, LLC.

I/O

Audio In/Out	Line-in 1ea / Line-out 1ea / Internal Mic 1ea
Alarm In	1 TTL, NC/NO Programmable, 4.3V(NC) or 0.3V(NO) threshold, 5V DC
Alarm Out	1 TTL open collector, Max. load: 30mA, Max. voltage: 5VDC

General

Vandal Resistance	Yes **	
Out-door Ready	IP66 **	
Operating Temperature	-10°C ~ +50°C (+14°F ~ +122°F)	
Boot Up Temperature	0°C ~ +50°C (+32°F ~ +122°F)	
Operating Humidity	0% ~ 90%	
Power Source	12VDC, PoE(IEEE 802.3af, Class 3)	
Power Consumption	Max. 7.56 W	
Approval	FCC, CE	
External Dimensions (Ø x H)	DC-Y1513W	155 mm x 48.3 mm (6.10" x 1.90")
	DC-Y1513	155 mm x 43 mm (6.10" x 1.69")
	DC-Y1514W	155 mm x 48.3 mm (6.10" x 1.90")
	DC-Y1514	155 mm x 42.8 mm (6.10" x 1.68")
Weight (Main Unit)	DC-Y1513W	0.59 kg (1.31 lb)
	DC-Y1513	0.58 kg (1.28 lb)
	DC-Y1514W	0.55 kg (1.21 lb)
	DC-Y1514	0.54 kg (1.19 lb)

** Applies to *DC-Y1513W/DC-Y1514W* model only.



IDIS Co., Ltd.

For more information, please visit at
www.idisglobal.com